

PASSIVE INFRARED DETECTOR
QUAD ZONE VERSION

SUPER QUAD VERSION WITH DOUBLE CONDUCTIVE SHIELDING

FX-50QZ, FX-50QZL

FX-50SQ, FX-50SQL

ALARM MEMORY

ALARM MEMORY

■ FEATURES

- Quad Zone Logic
- Patented Double Conductive Shielding of Pyroelectric Element (FX-50SQ/50SQL)
- Patented MultiFocus Lens
- Look Down Zone
- Sealed Optics
- Temperature Compensation Circuit

■ EASY INSTALLATION

- Easy Wiring Knockouts
- Spare Terminal
- Wiring Guide
- Wide Wiring Space

■ FUNCTIONS

- Selectable Pulse Count (2 or 4)
- LED On/Off Switch
- Tamper Switch
- Selectable Alarm Memory for Negative or Positive (FX-50QZL/50SQL)

■ OPTION

- FA-3 Wall & Ceiling Mount Bracket. (Horizontally $\pm 45^\circ$ & Vertically 0° to -15°)
- FL-60N Curtain Long Range Lens. (60ft/18m)

1. INSTALLATION HINTS



2. DESCRIPTION AND OPERATION

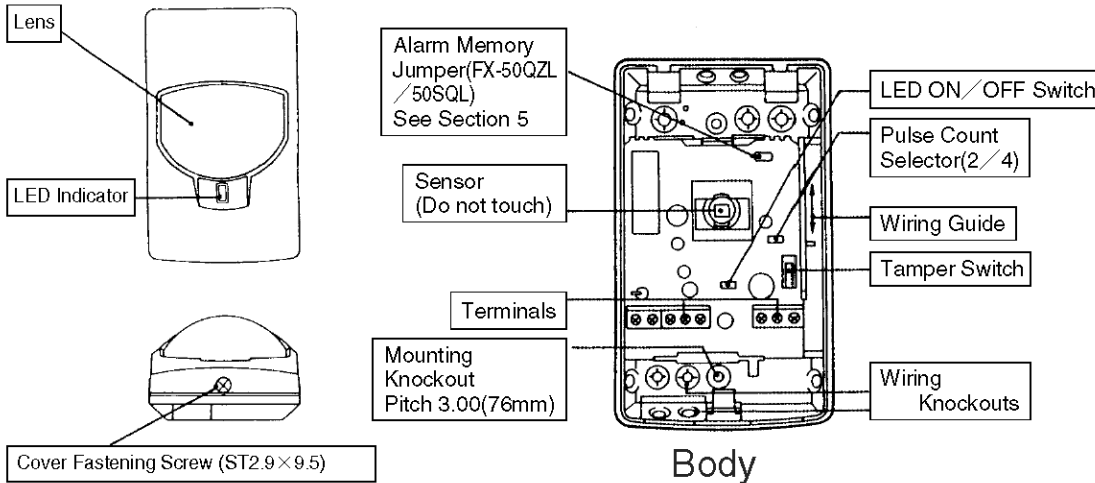

■ SELECTABLE ON/OFF & PULSE COUNT

Use the pin switch for LED ON/OFF & Pulse Count Selection (2 or 4)

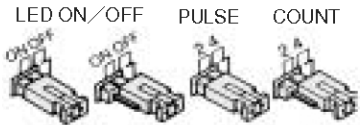

■ EASY WIRING KNOCKOUTS

Press by a screwdriver to open. Enlarge the hole according to size of wire.



3. DETECTION AREA

WIDE ANGLE

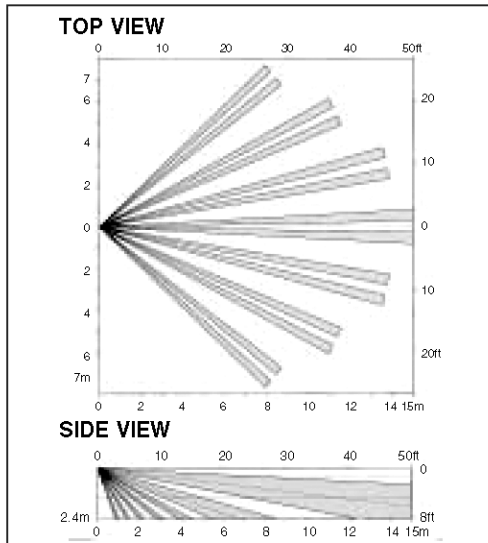

LONG RANGE (OPTIONAL LENS : FL-60N)

IMPORTANT
WHEN SELECTING THE LONG RANGE DETECTION PATTERN, ALWAYS SET PULSE COUNT SELECTOR ON "2".

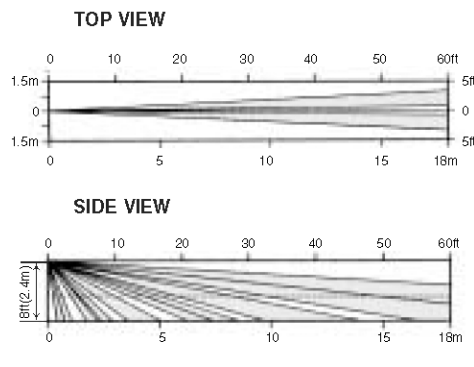

● PATTERN AREA SELECTION

Use an optional lens FL-60N for long range area

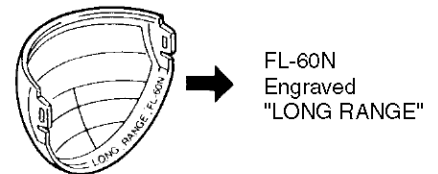

● HOW TO REMOVE & FIT LENS

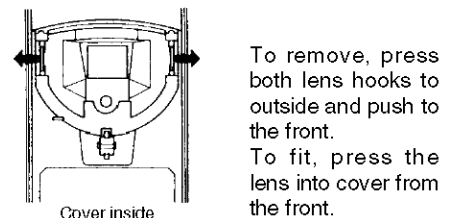

4. WIRING

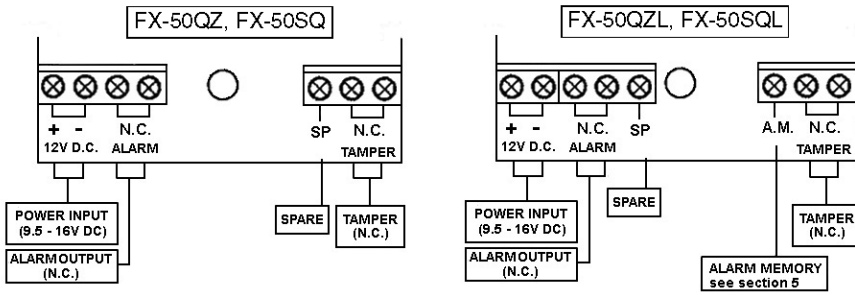

Power wires should not exceed the following lengths.

WIRE GAUGE	FX-50QZ, FX-50SQ		FX-50QZL, FX-50SQL	
	12V DC	14V DC	12V DC	14V DC
AWG22 (0.33mm ²)	1070' (320m)	2140' (650m)	770' (230m)	1530' (460m)
AWG20 (0.52mm ²)	1700' (510m)	3400' (1020m)	1200' (360m)	2400' (730m)
AWG18 (0.83mm ²)	2700' (820m)	5300' (1600m)	1900' (570m)	3800' (1150m)

When using two or more units on one wire, the maximum length is obtained by dividing the maximum wire length listed above by the number of units used.

5. ALARM MEMORY (FX-50QZL, FX-50SQL)

Compatible Control Panel is required for Alarm Memory.

Connect A.M. terminal to Control Panel's Control Voltage Signal terminal (System Arming Status Voltage Output).

AM Jumper

POSITIVE : Leave AM Jumper as it is
NEGATIVE : Cut AM Jumper as shown

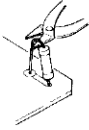

	POSITIVE	NEGATIVE
System Armed	OPEN or +5~16VDC	0~1VDC (grounded)
System Disarmed	0~1VDC (grounded)	OPEN or +5~16VDC

OPERATION OF ALARM MEMORY

If the unit triggered during armed period, when the system is disarmed, LED will remain lit to confirm that it reported an alarm.

- Alarm Memory will operate even when LED is switched OFF.
- Alarm Memory will not operate while system is disarmed.
- After Alarm Memory latches, Alarm Output and LED operate normally during armed period.

RESET

Alarm Memory resets automatically when system is re-armed.

6. TROUBLE SHOOTING AND MAINTENANCE

PROBLEM	PROBABLE CAUSE	REMEDY
LED does not light.	Incorrect power supply voltage. (disconnection, low voltage)	Correct the voltage supply to 9.5~16V DC.
	Incorrect detection area.	See Section 3
	Incorrect polarity to detector.	Switch positive and negative at terminal.
	LED switch is OFF	Turn on the Switch.
LED lights even though no person is within area.	Moving object within area. (curtain, wall hanging, etc.)	Remove object from detection area, or change location of detector.
	Rapid temperature changes within area. (heater, air-conditioner, etc.)	Remove the source from area, or change location of detection.
LED continues to light	Poor connection of alarm memory.	Reconnect wire.
	Wrong control voltage from panel.	Must be 0~1V DC. (grounded) See Section 5
LED lights but signal is not sent.	Relay contact is stuck or damaged due to overloading.	Check load of output. The unit needs repair or replacement.
	Faulty wiring	Wire correctly.

※ Conduct a walktest at least once year.

7. SPECIFICATIONS

MODEL	FX-50QZ, FX-50SQ
Detection method	Passive Infrared
Coverage	50ft×50ft (15m×15m) 85° wide
Detection zones	WIDE : 78 zones
Mounting Height	5~8ft (1.5~2.4m)
Sensitivity	3.6° F (2°C) at 2ft/sec (0.6m/sec)
Detectable speed	1~5ft/sec (0.3~1.5m/sec)
LED indicator	Alarm indicator optional
Alarm period	Approx. 2.5 sec
Alarm output	N.C., 28V DC 0.2A max.
Tamper switch	N.C., Open when cover is removed.
Pulse Count	Approx. 20 sec 2 or 4
Warm up period	Approx. 30 sec
Power input	9.5~16VDC
Current draw	17mA (max.)
Weight	3.2 oz (90g)
Operating temperature	-4° F ~ +122° F (-20°C ~ +50°C)
Environmental humidity	95% max
RF interference	NO Alarm 20V/m (FX-50QZ/50QZL)
	NO Alarm 30V/m (FX-50SQ/50SQL)

※ Specifications and design are subject to change without prior notice.

L Version (Alarm Memory)		
Model	FX-50QZL, FX-50SQL	
Position	Negative	Positive
Alarm Memory	armed : 0~1V DC (grounded)	armed : OPEN or +5~16V DC
Current draw	18mA (normal), 25mA (max.)	

FL-60N (Optional Lens for Long Range Area Pattern)	
Coverage	LONG : 60ft×6ft (18m×1.8m) Long Range
Detection zones	LONG : 20 zones

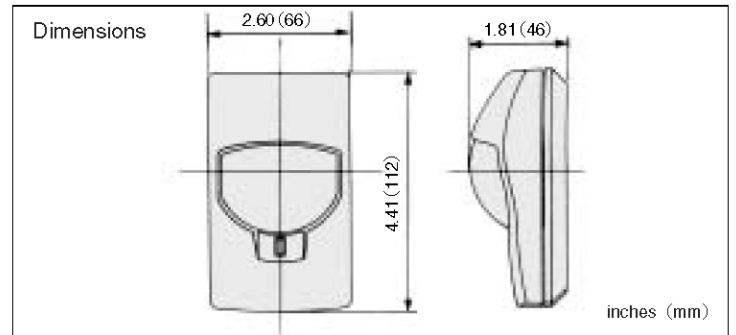

NOTE

This unit is designed to detect movement of an intruder and activate an alarm control panel. Being only a part of a complete system, we cannot accept responsibility for any damages or other consequences resulting from an intrusion. This Product conforms to category "Residential, Commercial and Light Industry" of EMC Directive. 89/336 EEC.

No 0845 9903-03

59-0845-2 99-8



OPTEX CO., LTD. (ISO 9001 Certified by LRQA)
4-7-5 Nonchama Otsu, 520-0801 Japan
TEL (077)594-8047 FAX (077)592-9022

OPTEX AMERICA, INC.
1645W. 205th Street Torrance, CA 90501-1510 U.S.A.
TEL (310)533-1500 FAX (310)533-6910

OPTEX (EUROPE) LTD. (ISO 9002 Certified by NQA)
Clivemont Road, Corowallis Park, Maidenhead, Berkshire, SL6 7BU U.K.
TEL (01628)651000 FAX (01628)656511